

Illusions[®]

Vinyl Fence

The Classic Face of the American Landscape



Beautify Your Outdoor Living Space • Enjoy Stylish Privacy & Security • Increase Your Property Value
100% Pure Virgin Vinyl Fence • Choose from 36 Colors and 5 Woodgrains



Why Illusions Vinyl Fence?

Because Your Home Deserves the Very Best!



You've done everything in your power to make your home fit your unique style.

Why would you settle for less from your fence?

You wouldn't. That's why Illusions Vinyl Fence is the perfect fit for your next fence installation. It's got everything you need all rolled up into a simple and affordable package.

As a part of the Eastern Fence Family with locations throughout the east coast, we have been manufacturing and distributing fence and railing products for almost 50 years. Nobody but nobody has more vinyl color and woodgrain than Illusions.

Designed with the sole purpose of allowing your creativity to flow, Illusions Vinyl Fence, Grand Illusions Color Spectrum, and Grand Illusions Vinyl Woodbond Series of vinyl fence products are the next step in the evolution of a product. Never before has fencing been done with such a huge degree of choices.

With 36 principal colors, 5 completely authentic woodgrains, and the ability to match a color of your choosing, you now have the perfect solution for your deck and railing. Both Grand Illusions Color Spectrum and Grand Illusions Vinyl WoodBond have a beautiful low gloss finish as well.

To find out more information, check out the website: www.illusionsfence.com



www.illusionsfence.com



Why Illusions Vinyl Fence?



ASTM F964-13 Compliant

ASTM F964-13 is considered the most recognized testing specification for vinyl. The purpose of this specification is to establish a recognized standard of quality for exterior vinyl profiles for use in assembling agricultural, commercial, and residential fencing and railing.



QuickShip™ InStock NO-WAIT Program

Got an important party coming up and need a fence quick?

Many styles of Illusions Vinyl Fence and their matching 4' and 5' wide gates are in stock and available for immediate shipment. Ask your fence installer for information on all current options.



Ready to Specify

Illusions Vinyl Fence styles are available on www.CADDetails.com to help you immediately specify for commercial and residential installations. Spec sheets, CAD files, PDFs, and more are ready to help you get your Illusions Fence installed today!



Made in the U.S.A.

Manufactured by Eastern Wholesale Fence, Illusions Vinyl Fence has been a household name in the fence industry for almost 30 years and is proudly manufactured in the United States of America.



Warranty

The best looking products in the industry give you a great warranty as well!

Classic Illusions Fence is protected by a comprehensive limited lifetime warranty, and Grand Illusions Color Spectrum and Grand Illusions Vinyl WoodBond products are protected by a twenty year pro-rated warranty. For details and warranty related questions, please visit the Illusions fence website at www.illusionsfence.com.



www.illusionsfence.com



PRIVACY

MATCHING ASSEMBLED GATES AVAILABLE FOR ALL ILLUSIONS FENCE STYLES!

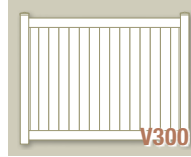

PRIVACY (6' OR 8' WIDE)

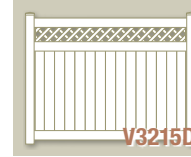

PRIVACY WITH DIAGONAL LATTICE

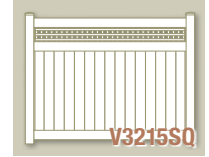

PRIVACY WITH SQUARE LATTICE

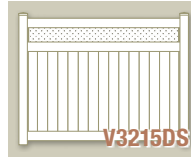

PRIVACY WITH SMALL DIAGONAL LATTICE

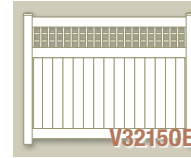

PRIVACY WITH OLD ENGLISH LATTICE



PRIVACY WITH STRAIGHT PICKET TOP

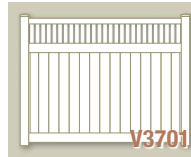

PRIVACY WITH FRAMED PICKET TOP

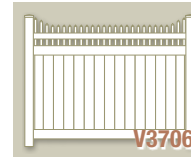

PRIVACY WITH STEPPED PICKET TOP



PRIVACY WITH SCALLOPED PICKET TOP

Privacy Panels feature a "V"-Jointed tongue and groove board and come with a wide variety of decorative tops. Privacy fence panels include a metal reinforcement channel in the bottom rail to help create a stronger and longer lasting fence. We pride ourselves on offering a Privacy Panel for every taste. They are also offered in color and woodgrain. Lattice comes in color and woodgrain.



CLASSIC CLAY

PRIVACY



CLASSIC GRAY AND WHITE



CLASSIC BEIGE AND CLAY



SEMI-PRIVACY



HORIZONTAL SEMI-PRIVACY WITH 3" BOARDS

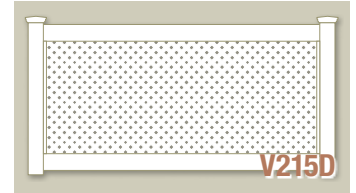

SMALL DIAGONAL LATTICE

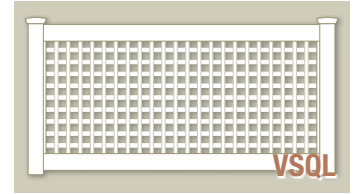

OLD ENGLISH LATTICE

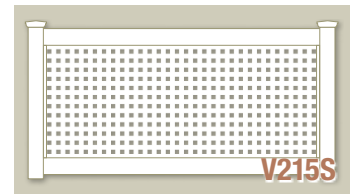

SQUARE LATTICE

The Illusions Vinyl Fence Semi-Privacy line has one of the largest selections offered and is specially designed for basic privacy without a "closed in" feeling. This extensive selection offers standard semi-privacy styles with space between the boards to allow air to flow through as well as the well known Board-on-Board styles with overlapping boards that provide both privacy and airflow.

Also popular in the Semi-Privacy series is "Old English Lattice." It's designed to look like a vinyl version of the common fence style used for growing vines, gardens, and hedgerows. Semi-Privacy fence panels include a metal reinforcement channel in the bottom rail to help create a stronger and longer lasting fence. Available in colors and woodgrains.

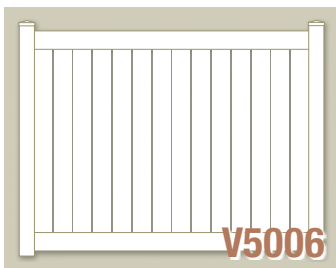

SEMI-PRIVACY WITH 6" BOARDS

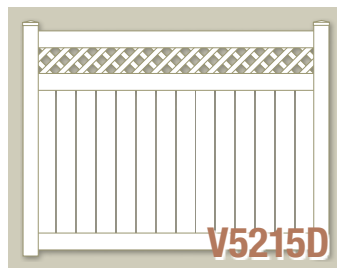

SEMI-PRIVACY WITH 6" BOARDS AND DIAGONAL LATTICE

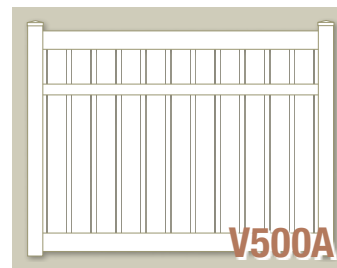

SEMI-PRIVACY WITH ALTERNATING 6" AND 1-1/2" BOARDS

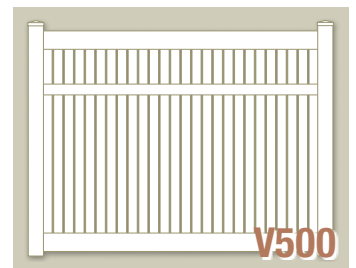

SEMI-PRIVACY WITH 3" BOARDS

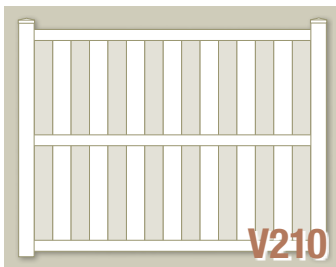

BOARD ON BOARD

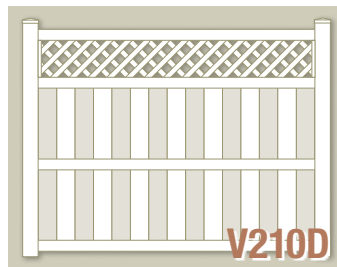

BOARD ON BOARD WITH DIAGONAL LATTICE

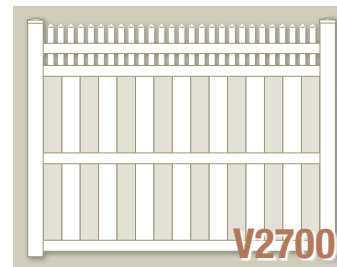

BOARD ON BOARD WITH STRAIGHT PICKET TOP

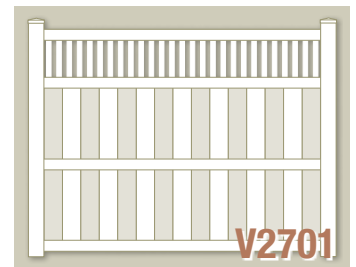

BOARD ON BOARD WITH FRAMED PICKET TOP

CLASSIC VICTORIAN PICKET

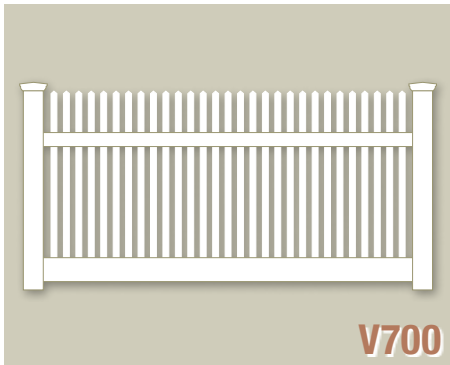

1-1/2" X 1-1/2" STRAIGHT TOP PICKET

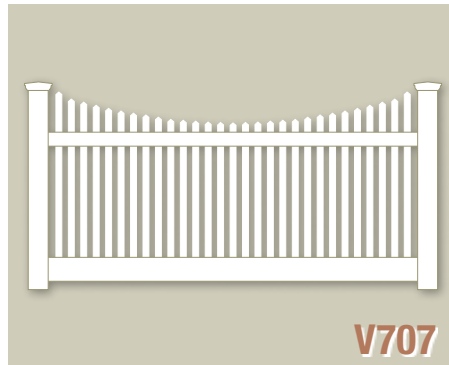

1-1/2" X 1-1/2" SCALLOPED PICKET

One of the most popular fence styles in the USA is the Illusions Vinyl Fence Classic Victorian Picket.

Using 1-1/2" x 1-1/2" pickets, it is a maintenance-free look alike of the old red cedar fence. All of the panels are carefully designed with the classic look in mind and are available in colors and woodgrains.

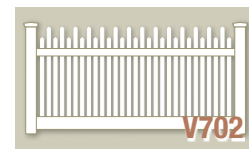

1-1/2" X 1-1/2" STAGGERED TOP PICKET

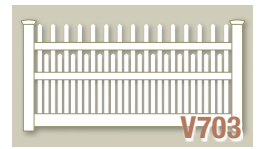

1-1/2" X 1-1/2" STAGGERED PICKET

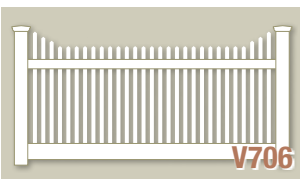

1-1/2" X 1-1/2" STEPPED TOP PICKET

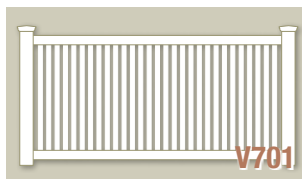

1-1/2" X 1-1/2" FRAMED TOP PICKET

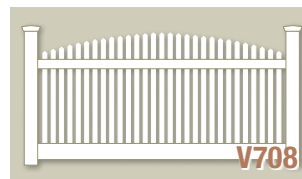

1-1/2" X 1-1/2" ARCHED TOP PICKET

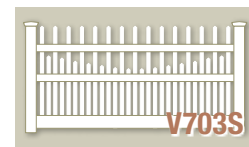

1-1/2" X 1-1/2" STAGGERED SCALLOPED PICKET



1-1/2" X 1-1/2" FRAMED STAGGERED PICKET

CONTEMPORARY PICKET



7/8" X 3" PICKETS WITH DOG-EAR PICKET CAPS



7/8" X 3" ARCHED PICKETS W/ DOG-EAR PICKET CAPS



7/8" X 3" PICKETS W/ POINTED PICKET CAPS



7/8" X 3" SCALLOPED PICKETS W/ POINTED PICKET CAPS



7/8" X 3" STEPPED PICKETS W/ POINTED PICKET CAPS



7/8" X 3" PICKETS WITH POINTED PICKET CAPS (REDUCED SPACING)



7/8" X 1-1/2" PICKETS W/ POINTED PICKET CAPS

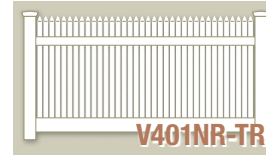

7/8" X 1-1/2" PICKETS W/ POINTED PICKET CAPS (REDUCED SPACING)

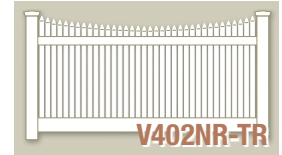

7/8" X 1-1/2" SCALLOPED W/ POINTED PICKET CAPS (REDUCED SPACING)

Illusions Contemporary Picket Fence offers what is known as the "good neighbor" approach to fencing. It is a fence that features both sides of the panels being exactly the same. The pickets are assembled THROUGH the rails instead of simply being attached to them. Available in colors and woodgrains.

ORNAMENTAL PICKET



Illusions Ornamental 1" x 1" Picket is a vinyl alternative to the wrought iron fence. It enables you to maintain the look of wrought iron without the maintenance. Available in colors and woodgrains.

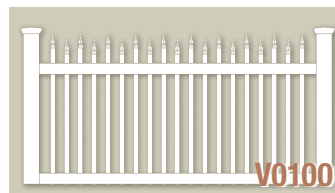

1" X 1" ORNAMENTAL PICKET FENCE WITH STAGGERED PICKET TOPS

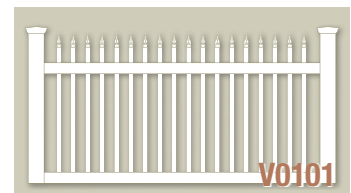

1" X 1" ORNAMENTAL PICKET FENCE WITH STRAIGHT PICKET TOP

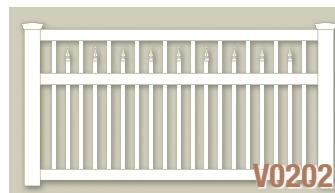

1" X 1" ORNAMENTAL PICKET FENCE WITH STAGGERED FRAMED PICKET TOP

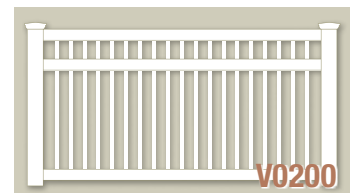

1" X 1" FRAMED TOP ORNAMENTAL PICKET FENCE

PICKET TOP STYLES



ARROWHEAD



BOY SCOUT



GOthic

POST & RAIL



CLASSIC BEIGE

Illusions Post & Rail fence is available with three different styled rails for the Two-Rail, Three-Rail, Four-Rail or Crossbuck fence. Whatever setting you may have, Illusions has the look you want and the strength you need. You can also get your Illusions Post & Rail styles in Grand Illusions colors and woodgrains.



2-RAIL



3-RAIL



4-RAIL

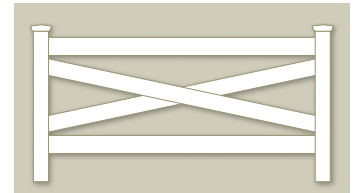

CROSSBUCK



2-RAIL DIAMOND



3-RAIL DIAMOND

RAILING



CLASSIC CLAY

Illusions offers a complete line of vinyl railings. All Illusions Vinyl Railing System railing panels contain a metal channel in the top-rail. Some styles are also offered in Grand Illusions colors and woodgrains. Illusions Vinyl Railings also offers an *optional* metal channel for the bottom rail for extra protection.

See page 27 for more information on Illusions Vinyl Railings.

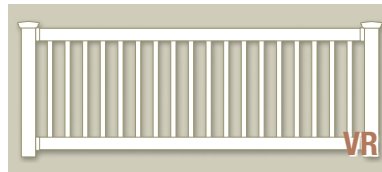

TRADITIONAL - 2" X 3.5" TOP-RAIL

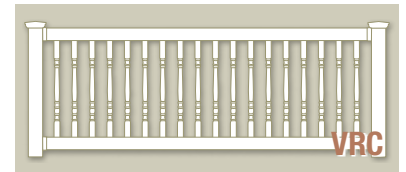

COLONIAL - 2" X 3.5" TOP-RAIL

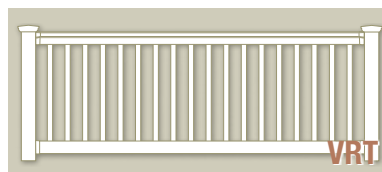

TRADITIONAL - T-RAIL TOP-RAIL

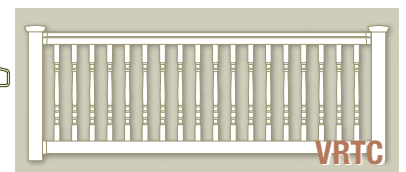

COLONIAL - T-RAIL TOP-RAIL

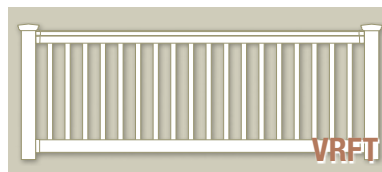

TRADITIONAL - FLAT T-RAIL TOP-RAIL

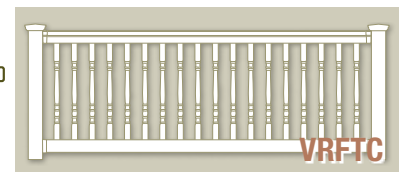

COLONIAL - FLAT T-RAIL TOP-RAIL

CURVES & TRANSITIONS

Simple to Order Matching Accessories for Your Illusions Vinyl Fence

Enhance the look and feel of your Illusions Vinyl Fence with these readily available curved and bent rails. Perfect for unique fence styles, transition sections, or for rounded corners of your property. All rails are available in all colors and woodgrains.

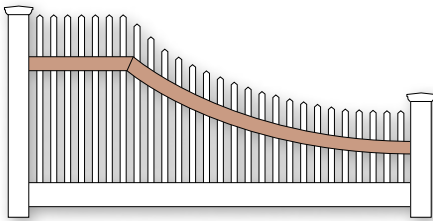

WATERFALL "A" SLOPE RAIL

Available in ALL fence styles

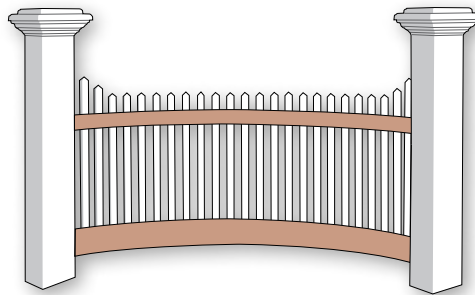

RADIUS "E" RAIL

Only available in picket fence styles

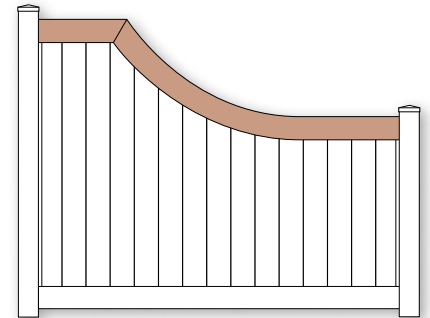

WATERFALL "H" RAIL

Available in all full privacy and Semi-privacy fence styles

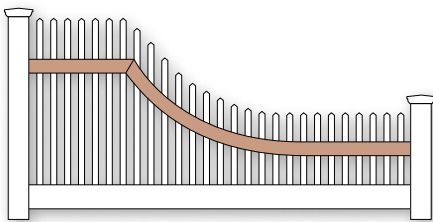

WATERFALL "B" SWEEP RAIL

Available in ALL fence styles

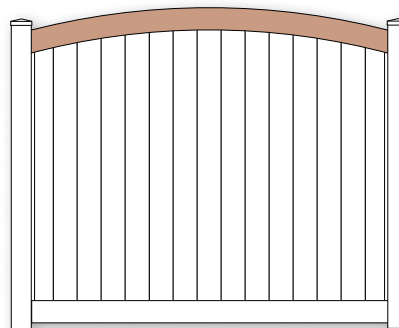

CROWNED "F" RAIL

Available in all full privacy and Semi-privacy fence styles

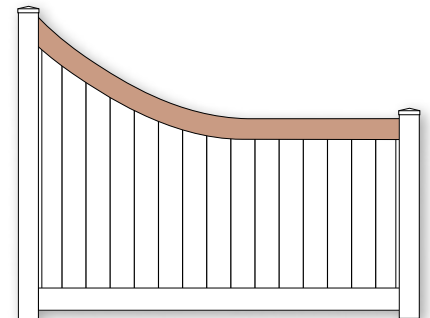

SWEEP "I" RAIL

Available in all full privacy and Semi-privacy fence styles

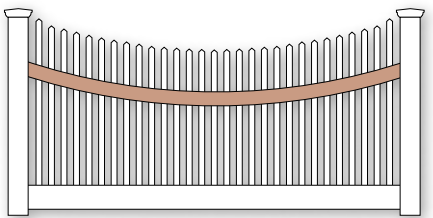

SCALLOPED "C" RAIL

Available in ALL fence styles

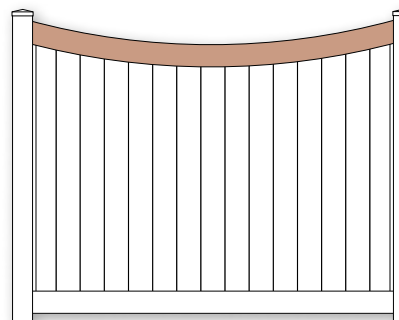

SCALLOPED "G" RAIL

Available in all full privacy and Semi-privacy fence styles

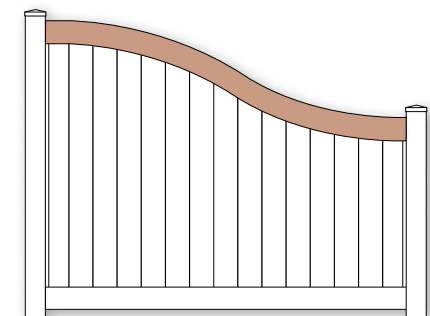

S-CURVED STYLED "J" RAIL

Available in all full privacy and Semi-privacy fence styles

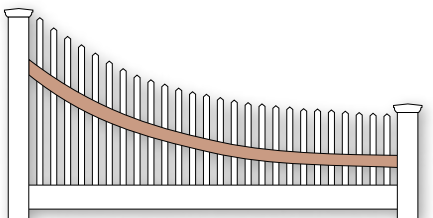

SWEEP "D" RAIL

Available in ALL fence styles

CURVES & TRANSITIONS

Simple to Order Matching Accessories for Your Illusions Vinyl Fence

Transition sections are used when you need to change the height of a fence run.
 Perfect for backyard to front yard height adjustments, ending sections, corner accents, and more!
 All rails are available in all colors and woodgrains.

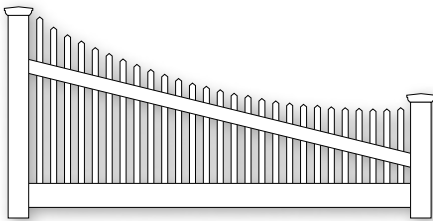

SW-A (Sweep Pickets / Angled Rail)
 Available in all picket fence styles

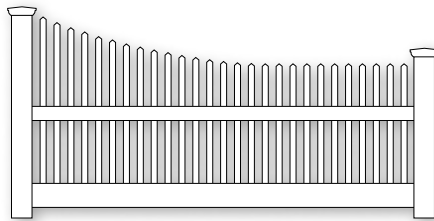

SW-S (Sweep Pickets / Straight Rail)
 Available in all picket fence styles

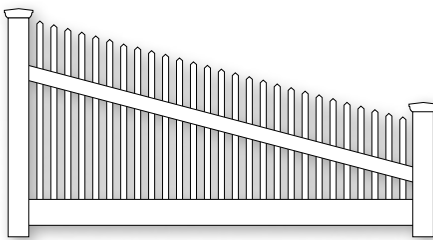

TAP-A (Tapered Pickets / Angled Rail)
 Available in all picket fence styles

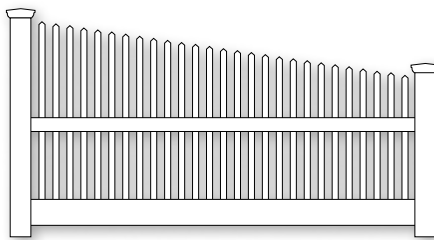

TAP-S (Tapered Pickets / Straight Rail)
 Available in all picket fence styles

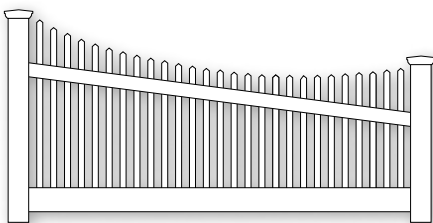

SCAL-A (Scalloped Pickets / Angled Rail)
 Available in all picket fence styles

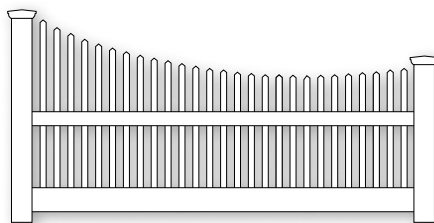

SCAL-S (Scalloped Pickets / Straight Rail)
 Available in all picket fence styles

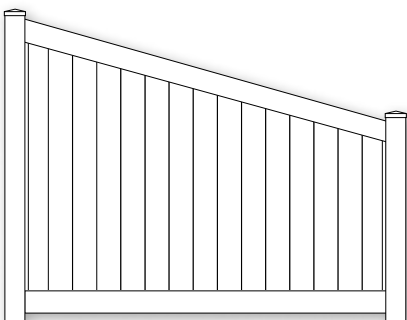

TAPER (Straight Taper)
 Available in all privacy and Semi-privacy styles

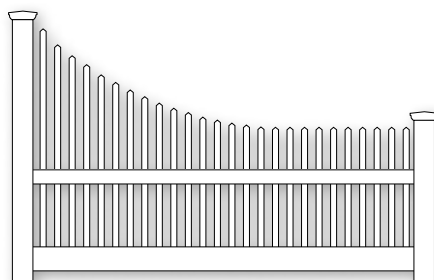

SL-S (Sloped Pickets / Straight Rail)
 Available in all picket fence styles



TRANSITION "J" RAILS

Illusions Classic V3215DS section with a transition s-curved "J" Rail top and mid-rails. Shown in Classic Gray and White.



"D" - RAIL

VBD300 Illusions Classic V300 section with a curved "D" Rail style transition top rail. Shown in Classic White.

ARBORS & PERGOLAS

Illusions Arbors & Pergolas are an important option to help add flair to your fence installation by taking it from a good looking fence install to a great looking fence install in one simple step. Use with a gate or as a fun ornament for your landscaping.

**AVAILABLE
IN
COLORS
AND
WOODGRAINS
TOO!**

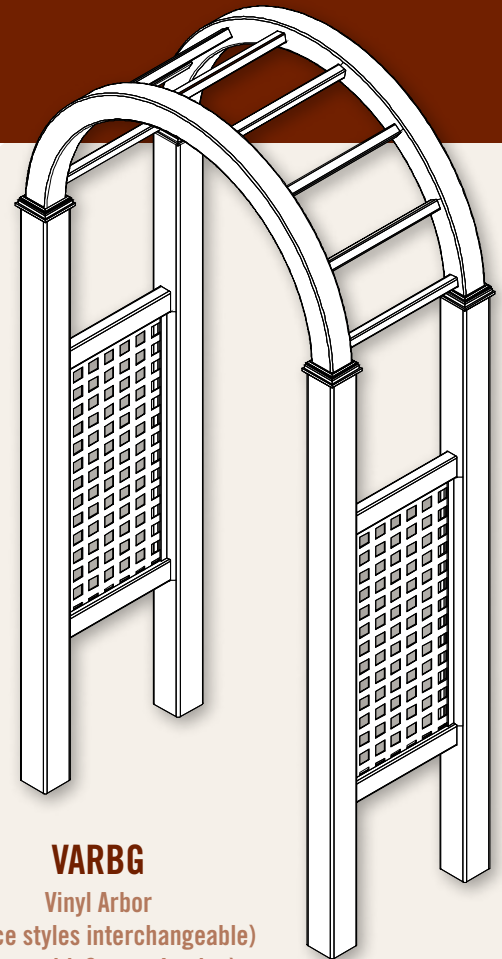

VARBG

Vinyl Arbor
(Lattice styles interchangeable)
(Shown with Square Lattice)

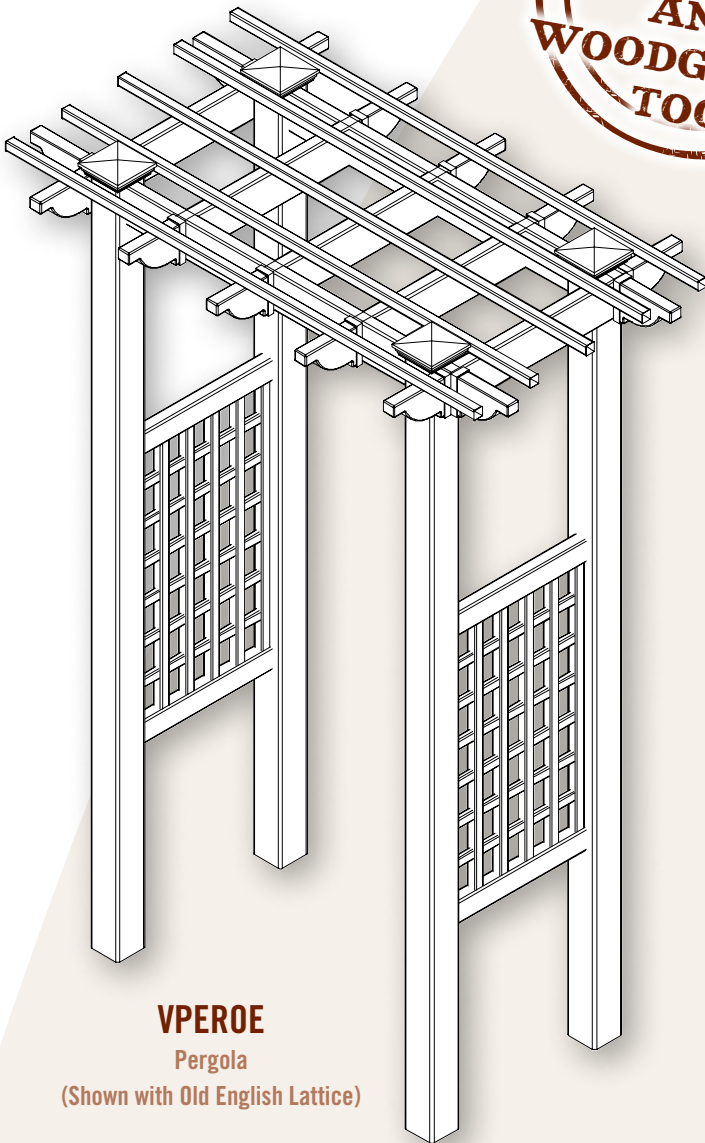

VPEROE

Pergola
(Shown with Old English Lattice)

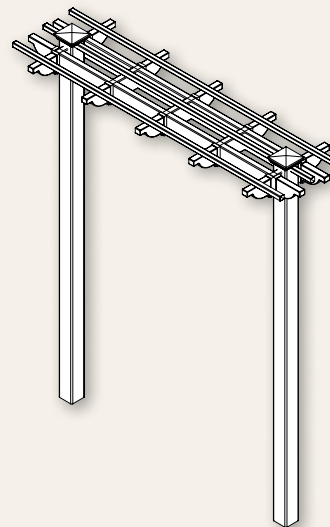

VPER2P

2 Post Pergola

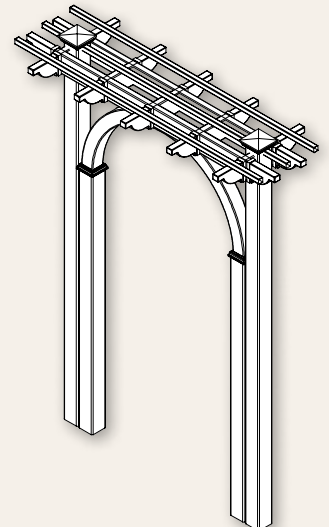

VPER4P

4 Post Pergola with Arch

ARBORS & PERGOLAS





LOW VOLTAGE LIGHTING

Low Voltage Fence, Railing, & Deck Lighting Solutions

Illusions Vinyl Fence Low Voltage Lighting Caps and Hardware are made to combine safety and quality with aesthetics. Lighting is one way that customers can add a unique touch to their deck, fence, or railing. Illusions lighting products are constructed with only high grade, commercial components.

Illusions Low Voltage Lighting was created to provide contractors and homeowners LED lighting solutions that are easy to install, reliable, and affordable.

These attractive lighting components will increase the enjoyment of any outdoor living space while also adding ambiance and safety.

- Simple and Easy to Install
- No wires to cut - plug together wiring harness
- Single power supply for all lights
- No need for an electrician or electrical permits
- Weather resistant connectors and lights
- Long-lasting LED's
- Housings are durable and UV stable
- Low voltage DC power supply
- Dusk to dawn light sensor
- Available with remote dimmer switch



VNPCL55W

5" Neptune Halo LV Post Cap - White
0.80 Watts

Also available in 4"
VNPCL44W



0.80 Watts

VHPCL44W

4" Halo LV Light - White



0.80 Watts

VDPCL44W

4" Downward LV Post Cap - White



0.80 Watts

VCPC44W

4" Combo LV Post Cap Light



0.80 Watts

VLDOMEW

LV Dome Side Light - Scalloped Lens



0.40 Watts

VLSTW

LV Side/Stair Light (Comes with 2 Covers)

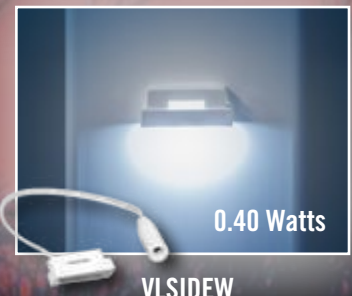

0.40 Watts

VLSIDEW

Ornamental LV Side Light



V55FO
EXTERNAL
FLAT

V55NE
NEW ENGLAND

V55FG
FRENCH
GOTHIC

V55P
PALACE
SOLAR

V55SO
SOLAR

V55BC
BALL

V55CM
COACHMAN

V55TD
TEARDROP

V55FD
FEDERATION

Picket Caps



V783PC
POINTED CAP
7/8" x 3"

V783DEC
DOG EAR CAP
7/8" x 3"

V786DEC
DOG EAR CAP
7/8" x 6"

V7815PC
POINTED CAP
7/8" x 1-1/2"

V15PC
PYRAMID CAP
1-1/2" x 1-1/2"

V11FG
FRENCH GOTHIC
1" x 1"

V11RF
ARROWHEAD
1" x 1"

V11TF
BOY SCOUT
1" x 1"

HARDWARE

Hinges

All Illusions Gate Hardware is custom designed to our specifications and manufactured using only the highest quality materials held to the same rigorous standards we use for all of our products. Many of our products are available in black, white, and bronze. Use a Vinyl Gate Stopper (VGS or VGSH) on all gates and two sets of Drop Rods (DRAS) on double drive gates.

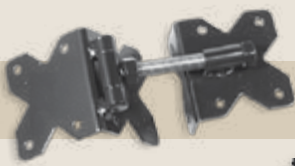

CPH55
CORNER PLATE HINGE
(Black or White)
(Sold in pairs)



CPH55S
SPRING LOADED CORNER
PLATE HINGE
(Black, White, or Bronze)
(Sold in pairs)



THSL
TRUE-CLOSE
SPRING HINGE
(Black Only)
(Sold in pairs)



THAHD-BK
ADJUSTABLE TRUE-CLOSE
SPRING HINGE
(Black or White)
(Sold in pairs)



IESH
X-TRA STRONG HINGE
(Black or White)
(Sold in pairs)

Latches



MLDD-BK
MAGNETIC GATE LATCHES
(Black or White)



MLS-BK
SMALL MAGNETIC GATE
LATCHES
(Black or White)

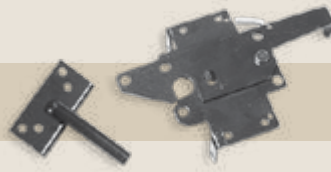

HLSS
STAINLESS STEEL
HATCHET LATCH
(Black, White, or Bronze)



V21SS
STAINLESS STEEL GRAVITY
LATCH W/PLATE
(Black, White, or Bronze)



V21LL
GRAVITY LATCH
KEYED 2-SIDES
(Black or White)

Misc.



DRAS OR DRAS48
24" OR 48" DROP ROD
(Black or White)
(Bronze Also for 24")



VGSH
GATE STOP/HANDLE COMBO
(Black or White)



VHDL
GATE HANDLE
(Black, White, or Bronze)



VGS
PVC GATE STOP
(Black or White)



CSB-12SS
STAINLESS STEEL SPRING CLOSER
(Black or White)

NOTE: Items on this page are not to scale.

COLOR OPTIONS

Classic Series

Looking for something simple and timeless?

Check out your 4 Illusions "Classic" color options. White, Beige, Gray, and Clay.

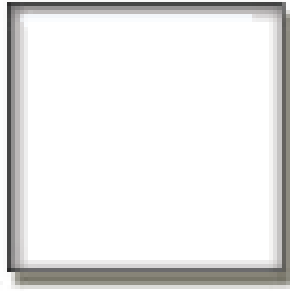

CLASSIC WHITE



CLASSIC BEIGE

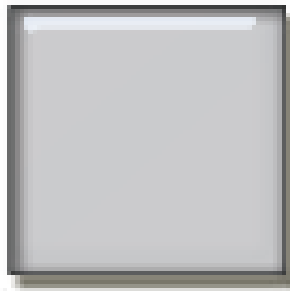

CLASSIC GRAY

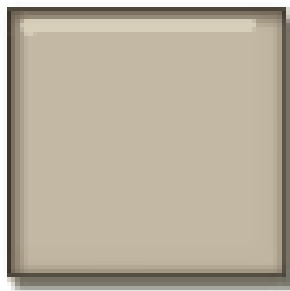

CLASSIC CLAY

ALL COLORS SHOWN ARE APPROXIMATE. SEE PHYSICAL SAMPLE FOR ACTUAL COLOR.



QuickShip V300-6CL
6' Height Tongue and Groove panels with 7/8" x 6" boards, 1-1/2" x 5-1/2" top and bottom horizontal rails, a metal reinforcement channel in the bottom rail, and 7/8" x 1" U-Channel edgings to add a unique and attractive aesthetic. Shown in the color Classic Clay.



All Classic Series Colors Are Available in V300-6 **QuickShip**[™]
For other styles and colors that are in stock all the time, just look for the **QuickShip** logo.

COLOR OPTIONS

Color Vinyl Fence!

All Illusions Fence Styles are available in ALL colors!

Grand Illusions Color Spectrum™ is the next evolution of a product. Choose from 32 different low gloss colors of vinyl fence. You can even let your creativity flow by mix 'n' matching your colors to create incredible fence installations.



Black



Brown



Hunter Green

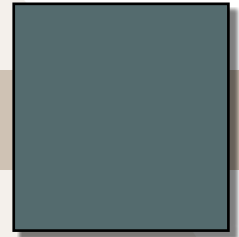

Slate Gray

Grand Illusions Color Spectrum FOCUS COLORS

Handpicked to match the most requested home accents and backyard blending options, the Focus Colors are some of the most popular color options in the Illusions Vinyl Fence product line.

(These colors are not available through the QuickShip™ program. Ask your local dealer for delivery times.)

ALL COLORS SHOWN ARE APPROXIMATE. SEE PHYSICAL SAMPLE FOR ACTUAL COLOR.



- 32 Principal Color Choices
- Low Gloss Matte Finish
- Available in All Styles
- Mix 'n' Match™ Your Colors
- Sky2Blue™ Color Protection



V300-6 6' high T&G vinyl privacy fence in Black

NOTE: All Grand Illusions Color and Woodgrain Fence Panels Ship Assembled

GRAND ILLUSIONS

VINYL WOODBOND

WOODGRAIN VINYL FENCE



Mahogany

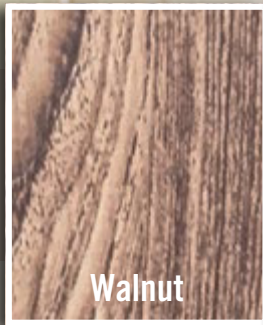

Walnut

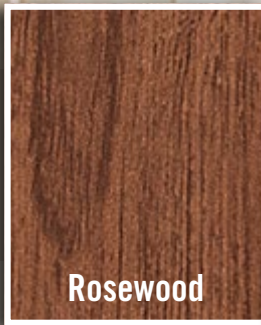

Rosewood

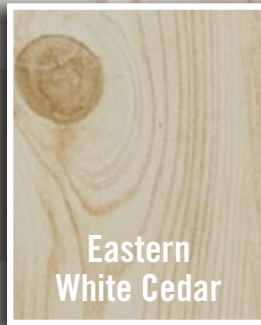

Eastern
White Cedar

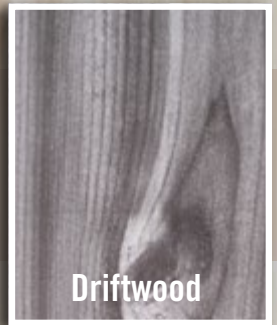

Driftwood

ALL COLOR SWATCHES SHOWN ARE APPROXIMATE. SEE PHYSICAL SAMPLE FOR ACTUAL COLOR.

V300-6 6' Height shown in Grand Illusions Vinyl WoodBond Eastern White Cedar with French Gothic (V55FG) post caps



Endless Color Possibilities...

All of these beautiful low gloss Grand Illusions Color Spectrum colors are created to match common home accent colors. You can Mix 'n' Match™ them with any other Illusions colors as well. (These colors are not available through the QuickShip™ program. Ask your local dealer for delivery times.)

ALL STYLES AVAILABLE IN ALL COLORS.

Colors shown are approximate. See physical sample for actual color.

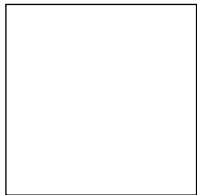

Patio White

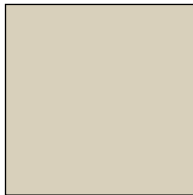

Tan

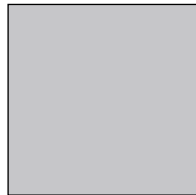

Seacoast Gray



Eastern Green

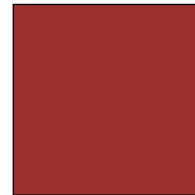

Barn Red

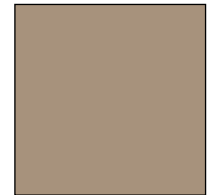

Adobe

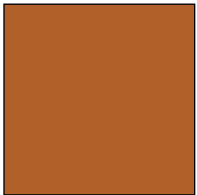

Autumn Orange

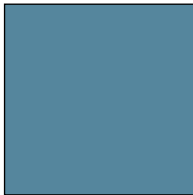

Federal Blue

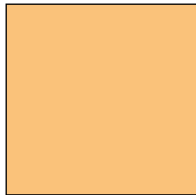

Colonial Yellow

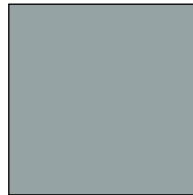

Millennium Gray

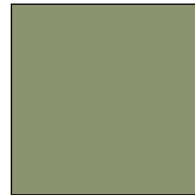

Evergreen

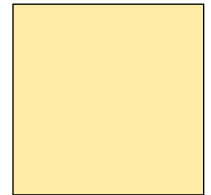

Sahara

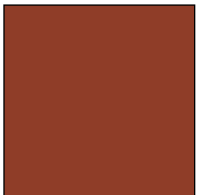

Brick Red



Olive



Burgundy

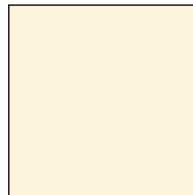

Antique White

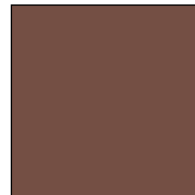

Brownstone

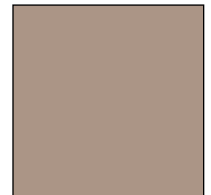

Prairie Dust

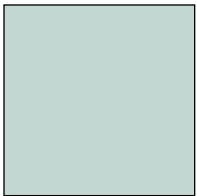

Sky Blue

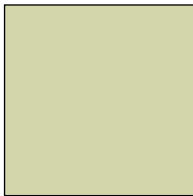

Sage



Midnight Blue



Atlantic Blue

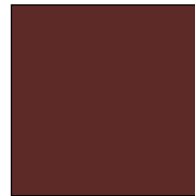

Bordeaux

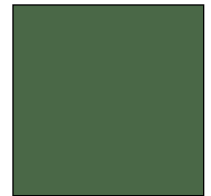

Forest Green

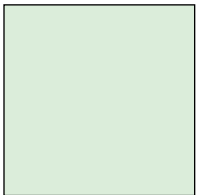

Seafoam Green



Vintage Wine

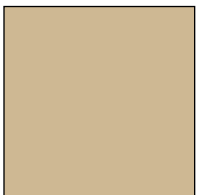

Desert Sand



Dark Royal Blue

Need a custom color?

Give us a swatch and we'll match it!

The *Grand Illusions Color Spectrum "Designer Series"* allows you to match any color. This creates limitless color possibilities for any fence application.





Rosewood



Classic White



Patio White



Classic White



NEW! Driftwood Horizontal Semi-Privacy



Classic White



Black



Eastern White Cedar



Patio White & Sahara



Classic Gray



Hunter Green

Fence Specifications



WHAT IS ASTM F964-13?

Scope

ASTM F964-13 is considered the “end all, beat all” testing specification for vinyl fence. The purpose of this specification is to establish a recognized standard of quality for exterior vinyl profiles for use in assembling agricultural, commercial, and residential fencing and railing. This specification covers Illusions Vinyl Fence sections and the EverStrong Profiles® used to fabricate them.

Materials

Illusions Vinyl Fence Products are manufactured using Rigid Poly Vinyl Chloride (PVC) compounds for exterior-profile extrusions that meet the requirements of ASTM Specification D4216.

Manufacture

Illusions Vinyl Fence Products are manufactured to meet cell Class 3–30233–23 as defined in Specification D4216. Illusions compounds have higher cell classification because one or more properties are superior to those used in standard acceptable compounds.

Color/Consistency Testing – The PVC compound in extruded section shall maintain uniform color and be free of any visual surface or structural changes, such as peeling, chipping, cracking, flaking, or pitting after weathering at intervals of six months and one year for white and for six months, one year, and two years for all other colors in hot, dry climate such as Phoenix, AZ; a hot humid climate, such as Miami, FL; and a temperate northern climate, when tested in accordance with ASTM Performance Weathering Requirements (TABLE 1).

Weathering Testing – The PVC compound shall have a minimum impact resistance of 0.6 in.-lb/mil (2670 J/m) after weathering six months and one year in a hot, dry climate such as Phoenix, AZ; a hot, humid climate, such as Miami, FL; and a temperate northern climate, when tested in accordance with ASTM Performance Weathering Requirements. The PVC compound shall have successfully met the weathering requirements prescribed for six months at each climatic testing site prior to use in production of exterior-profile extrusions, when tested in accordance with ASTM Performance Weathering Requirements (TABLE 1).

ASTM Specifications Met

- D256** - To determine Izod impact properties
- D618** – Practice for Conditioning Plastics for Testing
- D635** – Test Method for Rate of Burning and/or Extent and Time of Burning of Plastics in a Horizontal Position
- D638** - To determine tensile properties
- D648** - To determine heat distortion temperature
- D696** – Test Method for Coefficient of Linear Thermal Expansion of Plastics Between 030°C and 30°C with a Vitreous Silica Dilatometer
- D790** - To determine flexural properties
- D792** - To determine specific gravity
- D883** – Terminology Relating to Plastics
- D1435** – Practice for Outdoor Weathering of Plastics
- D1600** Terminology for Abbreviated Terms Relating to Plastics
- D1784** – Specification for Rigid Poly (Vinyl Chloride) (PVC) Compounds and Chlorinated Poly (Vinyl Chloride) (CPVC) Compounds
- D1898** – Practice for Sampling of Plastics
- D2240** - To determine Shore hardness values
- D2244** – Practice for Calculation of Color Tolerances and Color Differences from Instrumentally Measured Color Coordinates
- D2565** – Practice for Xenon-Arc Exposure of Plastics Intended for Outdoor Applications
- D4216** – Material Class Number1-32333-3. To establish Cell Classification of PVC material. Illusions compounds have higher cell classification because one or more properties are superior to those used in standard acceptable compounds
- D4226** – Test Methods for Impact Resistance of Rigid Poly-(Vinyl Chloride) (PVC) Building Products
- D4726** – Specification for Rigid Poly(Vinyl Chloride) (PVC) Exterior-Profile Extrusions Used for Assembled Windows and Doors
- E-84-04** - Used to determine the flame spread value of PVC material; Illusions burn rate is significantly lower than allowed value

Quality Assurance

Illusions Vinyl Fence Products are run through dimensional tests at the startup of a production run and every two hours thereafter including flattening, extrusion quality, impact resistance, warp, color comparison with standard color samples, capstock thickness, and bond testing will be done at the startup of a production and once per shift thereafter with a minimum of two tests per 24 hours of production.

TABLE 1 - Required Exposures for PVC Extrusions - In Process

Color of PVC Extrusions	Exposure Climate	Required Exposure Times, Months*
White	hot, dry (Phoenix, AZ)	6 and 12
	hot, humid (Miami, FL)	6 and 12
	northern temperate	6 and 12
Any other color	hot, dry (Phoenix, AZ)	6, 12 and 24
	hot, humid (Miami, FL)	6, 12 and 24
	northern temperate	6, 12 and 24

*It is recommended that separate specimens be used for each exposure time.

THESE ARE THE RESULTS FROM AN ACCELERATED WEATHER TESTING CHAMBER IN LABORATORY CONDITIONS

The Illusions® Vinyl Fence Advantage

This test is run according to ASTM Standard G-155, Cycle #1. All Illusions® Vinyl Fence Product is guaranteed to be made from 100% Pure Virgin Vinyl and assembled according to ASTM F964. Please note the difference in color retention and be assured, Illusions® Vinyl Fence will have uniformed color and be free of any visual surface or structural changes such as: peeling, chipping, cracking, flaking, or pitting after weathering.

Be assured! Insist on *Illusions® Vinyl Fence* Products.



Competitor:
450 Hrs.
(4-5 Years)



WOW!
THAT WOULD
COST A FORTUNE
IN RE-INSTALLS!



Illusions®:
1000 Hrs.
(10-11 Years)

Need Vinyl Railing Too?

Looking for the perfect railing to match your brand new Illusions Vinyl Fence?

From the tallest skyscraper to your front porch, ICC-ES AC174 certified Illusions Vinyl Railing System is the perfect choice for your next railing installation. Made of 100% Pure Virgin Vinyl, all styles are available in all colors and woodgrains.

(Ask your local Illusions dealer for the Illusions Vinyl Railing brochure to find out more.)



www.illusionsvinylrailing.com

Illusions[®]

Vinyl Fence

www.illusionsfence.com



- Beautify Your Outdoor Living Space
- Enjoy Stylish Privacy & Security
- Increase Your Property Value
- 100% Pure Virgin Vinyl - Fence
- Choose from 36 Colors and 5 Woodgrains



www.illusionsfence.com

Illusions products are sold wholesale to the trade.
Contact your local fence company for pricing.



Professional Fence Dealer